

# 2MP Bullet Network Camera Datasheet

IPC-B222-APF40



## Key Features

### Optics

- Day/night functionality
- Smart IR, up to 60m (196ft) IR distance
- Optical glass window with higher light transmittance
- IR anti-reflection window to increase the infrared transmittance
- 2D/3D DNR (Digital Noise Reduction)
- Built-in Mic

### Compression

- H.265, H.264
- ROI (Region of Interest)

### Network

- ONVIF Conformance

## Structure

- Wide temperature range: -30°C ~ 60°C (-22°F ~ 140°F)
- Wide voltage range of DC12V(±25%)
- IP67

## Specifications

IPC-B222-APF40					
<b>Camera</b>					
Sensor	1/3", progressive scan, CMOS				
Shutter	Auto/Manual, 1 ~ 1/100000s				
Minimum Illumination	Colour: 0.02 (F2.1, AGC ON) 0Lux with IR on				
WDR	DWDR				
<b>Lens</b>					
Lens Type	4.0mm @F2.1, Fixed-focal				
Field of View (H)	80.2°				
Field of View (V)	42.9°				
Field of View (D)	86.0°				
<b>DORI</b>					
	Lens (mm)	Detect (m)	Observe (m)	Recognize (m)	Identify (m)
DORI Distance	4.0	66.7	26.7	13.3	6.7
<b>Illuminator</b>					
IR Range	Up to 60m (196ft) IR range				
Wavelength	850nm				
IR On/Off Control	Auto/Manual				
<b>Video</b>					
Video Compression	H.265, H.264				
H.264 code profile	Baseline profile, Main profile, High profile				
Frame Rate	Main Stream: 2MP (1920*1080), Max 25fps; 720P (1280*720), Max 25fps; Sub Stream: D1 (720*576), Max 25fps; 640*360, Max 25fps; 2CIF(704*288), Max 25fps; CIF(352*288), Max 25fps;				
Video Bit Rate	128 Kbps~6 Mbps				
U-code	Supported				
OSD	Up to 4 OSDs				
Privacy Mask	Up to 4 areas				
ROI	Up to 8 areas				
Motion Detection	Up to 4 areas				
<b>Image</b>					
White Balance	Auto/Outdoor/Fine Tune/Sodium Lamp/Locked/Auto2				
Image Setting	Image rotation, brightness, saturation, contrast, sharpness, gain adjustable by web browser				
Digital Noise Reduction	2D/3D DNR				

Smart IR	Supported
Flip	Normal/Vertical/Horizontal/180°
Dewarping	N/A
HLC	Supported
BLC	Supported
Defog	Digital Defog
<b>Events</b>	
Basic Detection	motion detection, audio detection
General Function	Watermark, IP address filtering, access policy, ARP protection, RTSP authentication, user authentication, HTTP authentication
<b>Audio</b>	
Audio Compression	G.711A,G711U
Audio Bitrate	64 Kbps
Two-way audio	N/A
Suppression	Support
Sampling Rate	8KHZ
<b>Network</b>	
Protocols	IPv4, IGMP, ICMP, TCP, UDP, DHCP, RTP, RTSP, RTCP, DNS, DDNS, NTP, UPnP, HTTP, RTMP
Compatible Integration	ONVIF (Profile S, Profile T),API
User/Host	Up to 32 users. 2 user levels: administrator and common user
Client	Uniarch Client Uniarch APP
Web Browser	Plug-in free live view: Chrome 57.0+, Firefox 58.0+, Edge 16+
<b>Interface</b>	
Network	1 * RJ45 10M/100M Base-TX Ethernet
Built-in Mic	Supported
<b>Certifications</b>	
EMC	CE-EMC (EN 55032: 2015+A1:2020,EN 61000-3-3: 2013+A1: 2019,EN IEC 61000-3-2: 2019+A1: 2021,EN 55035: 2017+A1:2020) FCC (FCC CFR 47 part15 B, ANSI C63.4-2014)
Safety	CE LVD (EN 62368-1:2014+A11:2017) CB (IEC 62368-1:2014) UL (UL 62368-1, 2nd Ed., Issue Date: 2014-12-01)
Environment	CE-RoHS (2011/65/EU;(EU)2015/863); WEEE (2012/19/EU); Reach (Regulation (EC) No 1907/2006)
Protection	IP67 (IEC 60529:1989+AMD1:1999+AMD2:2013)
<b>General</b>	
Power	DC 12V±25%, PoE (IEEE 802.3af)
	Power consumption: Max 6.0W
Power Interface	Ø 5.5mm coaxial power plug
Dimensions (L × W × H)	246× 97 × 187mm (9.7" × 3.8" × 7.4")
Weight	0.65kg (1.43lb)
Working Environment	-30°C ~ 60°C (-22°F ~ 140°F), Humidity: ≤95% RH (non-condensing)
Surge Protection	4KV
Reset Button	N/A

## Dimensions

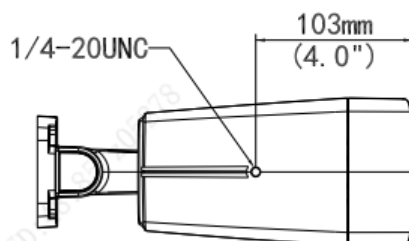
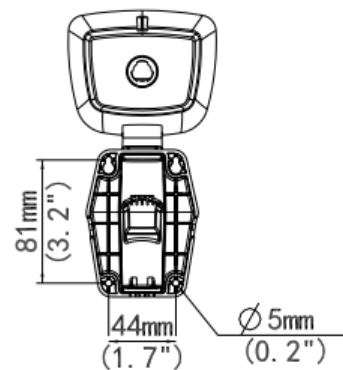
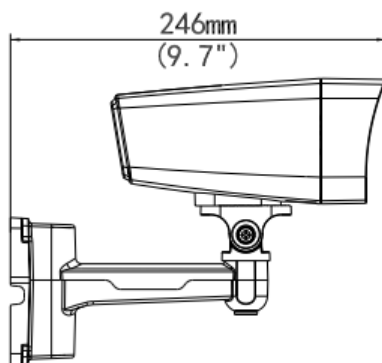
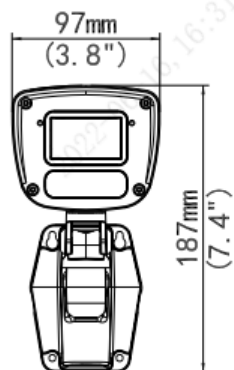

## Accessories

TR-WM07P-A  
Wall Mount

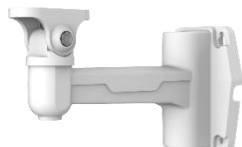

[www.uniview.com/uniarch](http://www.uniview.com/uniarch)

©2021 Zhejiang Uniview Technologies Co., Ltd. All rights reserved.

\*Product specifications and availability are subject to change without notice.